

PROPERTY : VINARES 1-10 (LOT: 20507, 20508, 20509 )

A2 TYPE ELEVATION PLAN

1:100

PROPERTY : VINARES 1-10 (LOT: 20507,20508, 20509 )	
DRAWING NAME : A2 TYPE ELEVATION PLAN	SCALE: AS GIVEN,A4

DRAWN BY : MAAHEE	DATE : 25/02/2024
CHECKED BY : MAHUDHEE	

REVISION NO.: R01	DATE : 26/02/2024
REVISED BY: MAAHEE	



REAL ESTATE MANAGEMENT  
 2ND FLOOR, CENTRO MALL, HULHUMALE  
 REPUBLIC OF MALDIVES  
 TEL +9603353535, FAX +9603358892  
 EMAIL : hello@hdc.mv

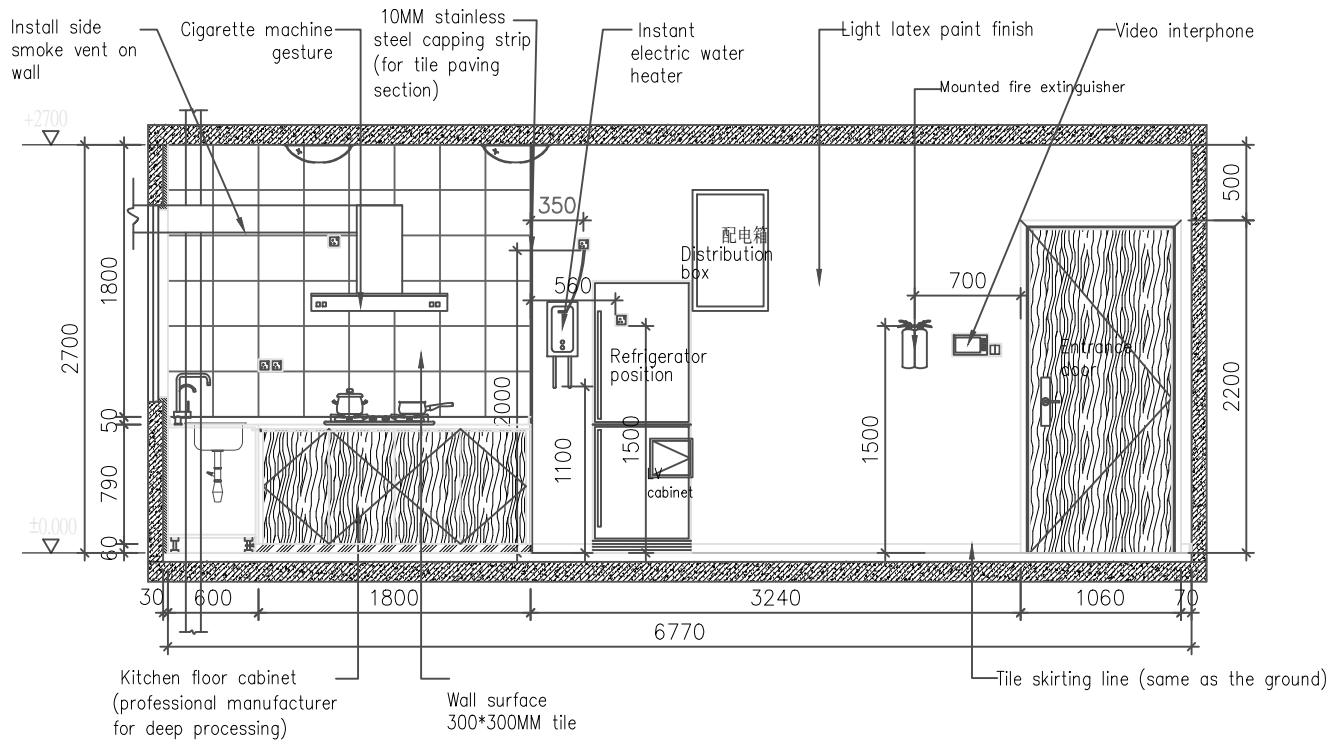

PROPERTY : VINARES 1-10 (LOT: 20507, 20508, 20509 )

A2 TYPE APARTMENT, DINING ROOM & LIVING

ROOM ELEVATION - 01 - A

1:50

PROPERTY : VINARES 1-10 (LOT: 20507,20508, 20509 )	
DRAWING NAME : A2 TYPE ELEVATION - 01- A	SCALE: AS GIVEN,A4

DRAWN BY : MAAHEE	DATE : 25/02/2024
CHECKED BY : MAHUDHEE	

REVISION NO.: R01	DATE : 26/02/2024
REVISED BY: MAAHEE	



REAL ESTATE MANAGEMENT  
 2ND FLOOR, CENTRO MALL, HULHUMALE'  
 REPUBLIC OF MALDIVES  
 TEL +9603353535, FAX +9603358892  
 EMAIL : hello@hdc.mv

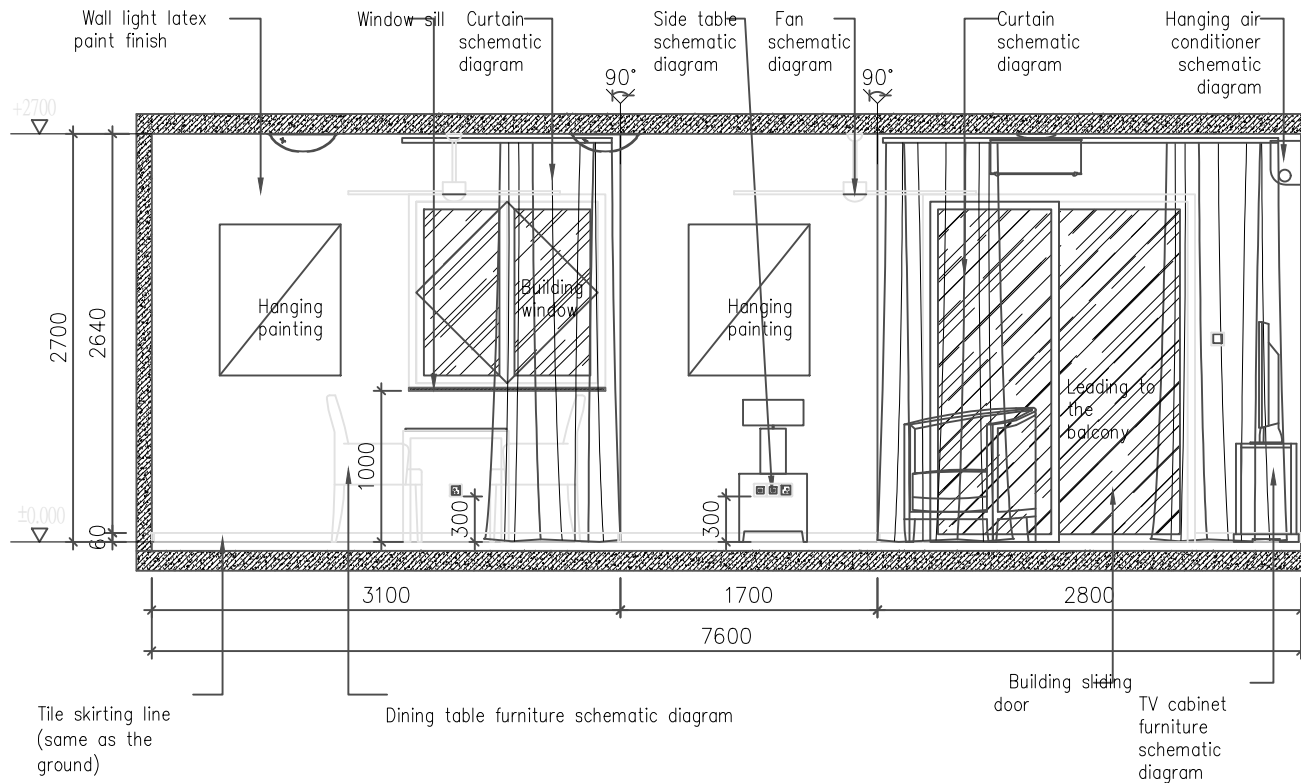

PROPERTY : VINARES 1-10 (LOT: 20507, 20508, 20509 )

A2 TYPE APARTMENT, DINING ROOM & LIVING

ROOM ELEVATION - 01- B

1:50

PROPERTY : VINARES 1-10 (LOT: 20507,20508, 20509 )	
DRAWING NAME : A2 TYPE ELEVATION - 01- B	SCALE: AS GIVEN,A4

DRAWN BY : MAAHEE	DATE : 25/02/2024
CHECKED BY : MAHUDHEE	

REVISION NO.: R01	DATE : 26/02/2024
REVISED BY: MAAHEE	



REAL ESTATE MANAGEMENT  
2ND FLOOR, CENTRO MALL, HULHUMALE'  
REPUBLIC OF MALDIVES  
TEL +9603353535, FAX +9603358892  
EMAIL : hello@hdc.mv

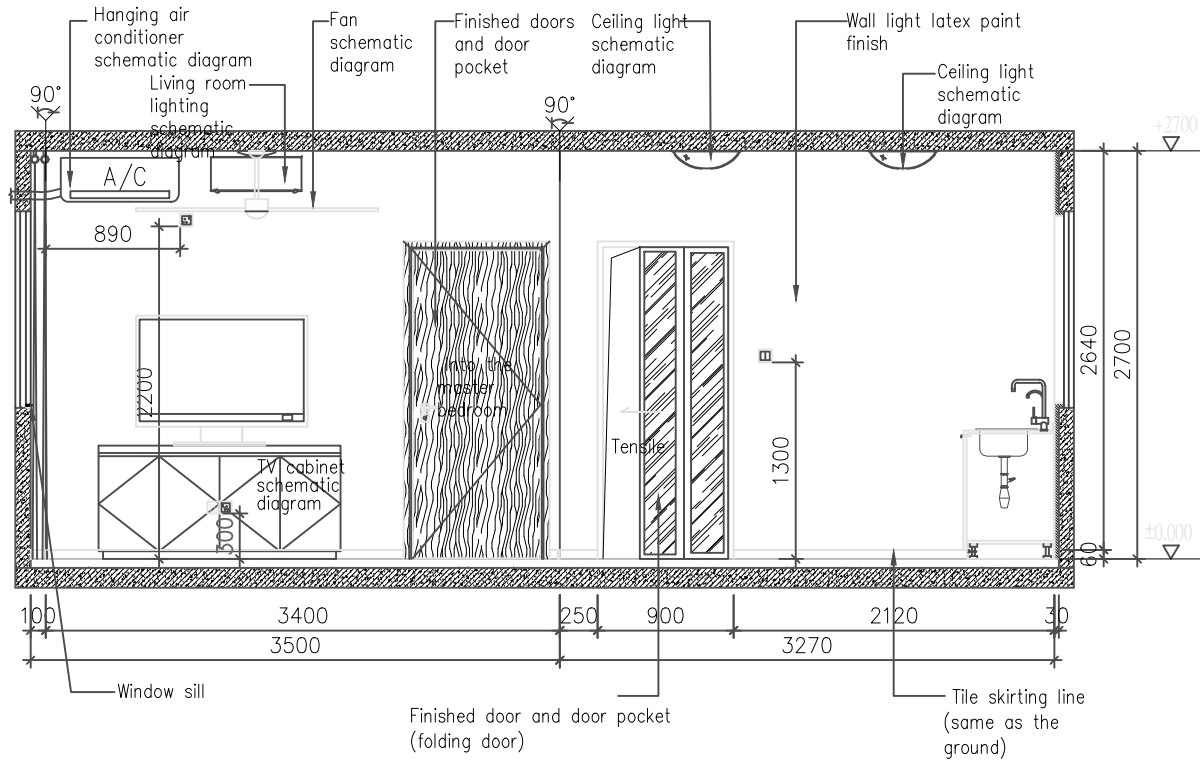

PROPERTY : VINARES 1-10 (LOT: 20507, 20508, 20509 )

A2 TYPE APARTMENT, DINING ROOM & LIVING

ROOM ELEVATION - 01- C

1:50

PROPERTY : VINARES 1-10 (LOT: 20507,20508, 20509 )	
DRAWING NAME : A2 TYPE ELEVATION - 01- C	SCALE: AS GIVEN,A4

DRAWN BY : MAAHEE	DATE : 25/02/2024
CHECKED BY : MAHUDHEE	

REVISION NO.: R01	DATE : 26/02/2024
REVISED BY: MAAHEE	



REAL ESTATE MANAGEMENT  
 2ND FLOOR, CENTRO MALL, HULHUMALE'  
 REPUBLIC OF MALDIVES  
 TEL +9603353535, FAX +9603358892  
 EMAIL : hello@hdc.mv

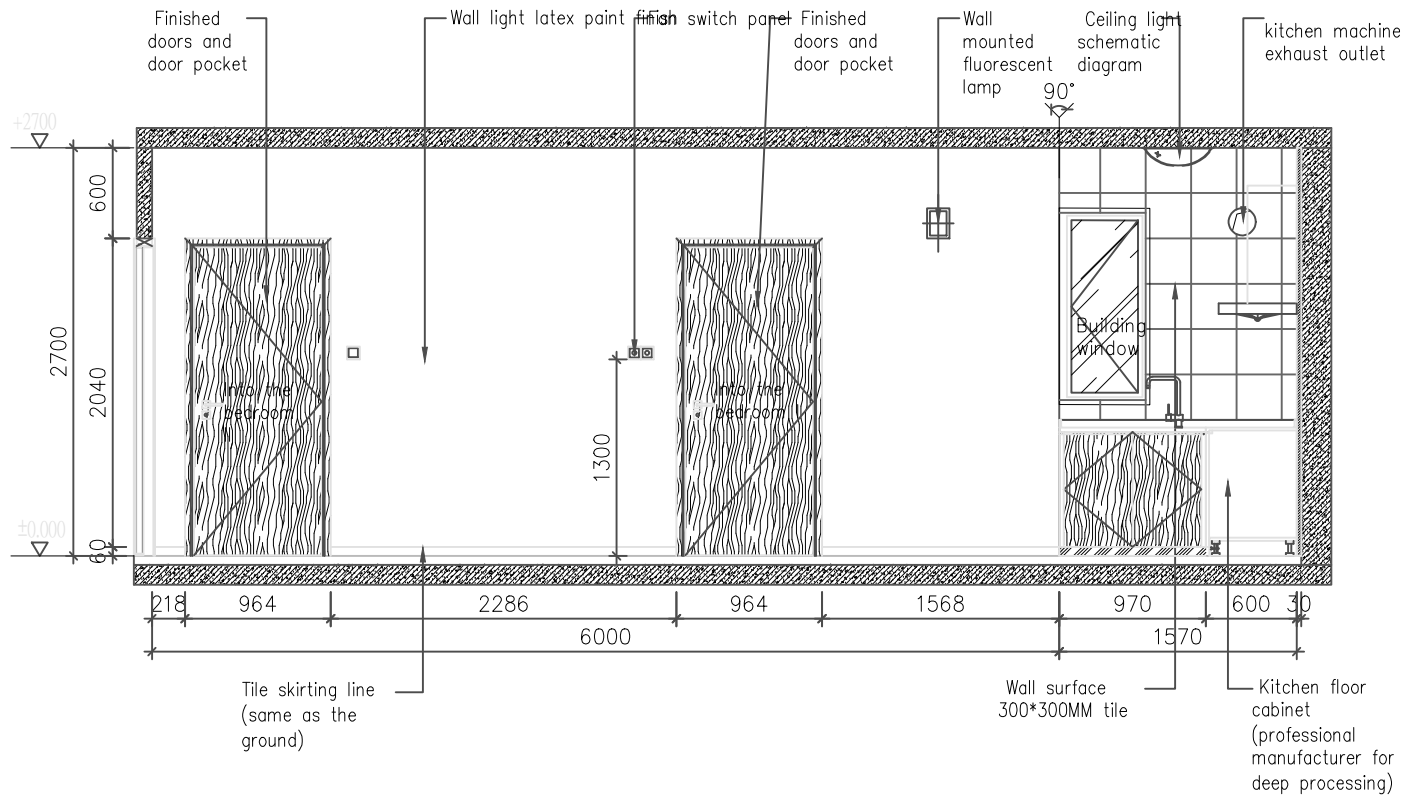

PROPERTY : VINARES 1-10 (LOT: 20507, 20508, 20509 )

A2 TYPE APARTMENT, DINING ROOM & LIVING

ROOM ELEVATION - 01- D

1:50

PROPERTY : VINARES 1-10 (LOT: 20507,20508, 20509 )	
DRAWING NAME : A2 TYPE ELEVATION - 01- D	SCALE: AS GIVEN,A4

DRAWN BY : MAAHEEE	DATE : 25/02/2024
CHECKED BY : MAHUDHEE	

REVISION NO.: R01	DATE : 26/02/2024
REVISED BY: MAAHEE	



REAL ESTATE MANAGEMENT  
2ND FLOOR, CENTRO MALL, HULHUMALE'  
REPUBLIC OF MALDIVES  
TEL +9603353535, FAX +9603358892  
EMAIL : hello@hdc.mv

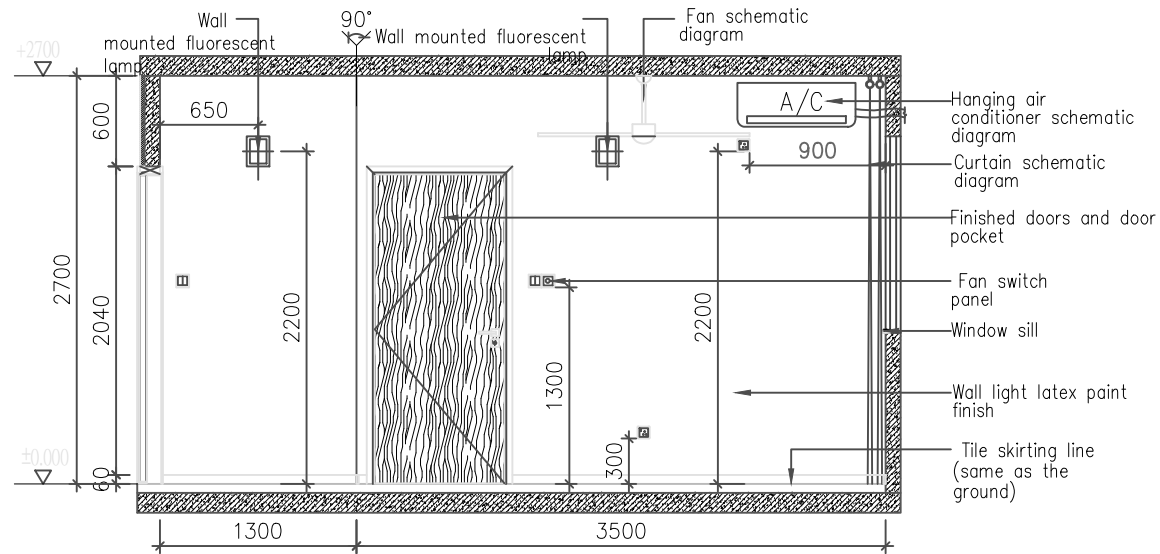

PROPERTY : VINARES 1-10 (LOT: 20507, 20508, 20509 )

A2 TYPE APARTMENT, MASTER BEDROOM

ELEVATION - 02 - A

1:50

PROPERTY : VINARES 1-10 (LOT: 20507,20508, 20509 )	DRAWN BY : MAAHEE	DATE : 25/02/2024	REVISION NO.: R01	DATE : 26/02/2024
DRAWING NAME : A2 TYPE ELEVATION - 02 - A	CHECKED BY : MAHUDHEE		REVISED BY: MAAHEE	
SCALE: AS GIVEN,A4				



REAL ESTATE MANAGEMENT  
 2ND FLOOR, CENTRO MALL, HULHUMALE'  
 REPUBLIC OF MALDIVES  
 TEL +9603353535, FAX +9603358892  
 EMAIL : hello@hdc.mv

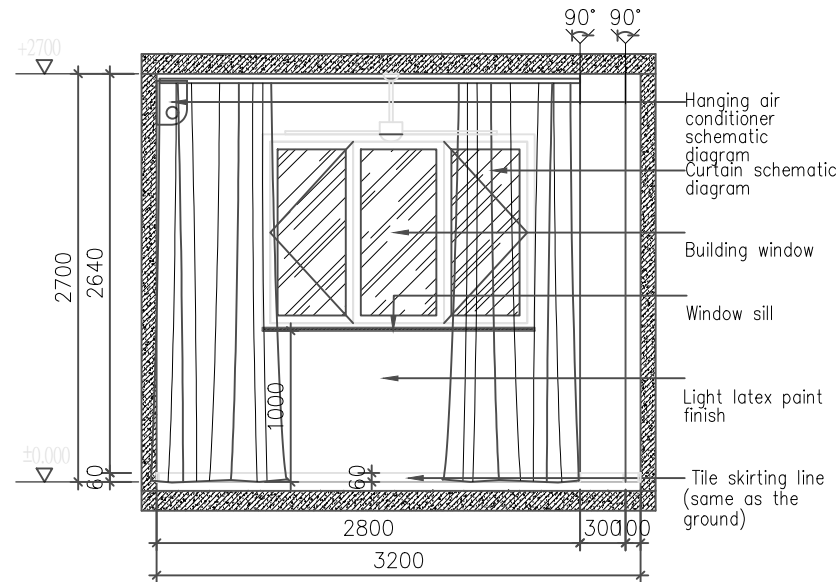

PROPERTY : VINARES 1-10 (LOT: 20507, 20508, 20509 )

A2 TYPE APARTMENT, MASTER BEDROOM

ELEVATION - 02 - B

1:50

PROPERTY : VINARES 1-10 (LOT: 20507,20508, 20509 )		DRAWN BY : MAAHEE	DATE : 25/02/2024	REVISION NO.: R01	DATE : 26/02/2024
DRAWING NAME : A2 TYPE ELEVATION - 02 - B	SCALE: AS GIVEN,A4	CHECKED BY : MAHUDHEE		REVISED BY: MAAHEE	



REAL ESTATE MANAGEMENT  
 2ND FLOOR, CENTRO MALL, HULHUMALE'  
 REPUBLIC OF MALDIVES  
 TEL. +9603353535, FAX +9603358892  
 EMAIL : hello@hdc.mv

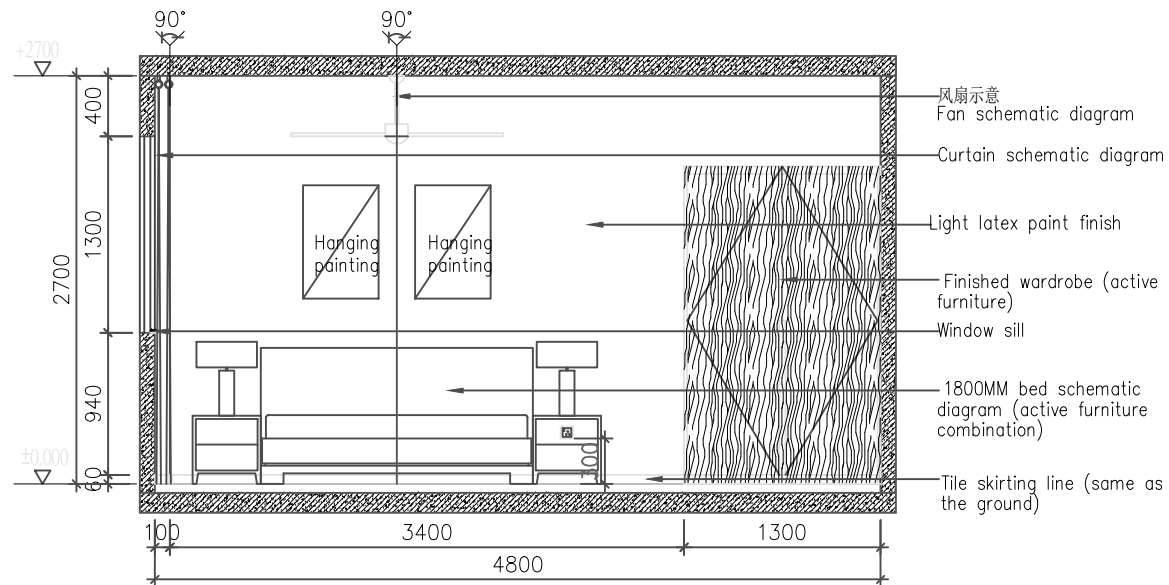

PROPERTY : VINARES 1-10 (LOT: 20507, 20508, 20509 )

A2 TYPE APARTMENT, MASTER BEDROOM

ELEVATION - 02 - C

1:50

PROPERTY : VINARES 1-10 (LOT: 20507,20508, 20509 )	
DRAWING NAME : A2 TYPE ELEVATION - 02 - C	SCALE: AS GIVEN,A4

DRAWN BY : MAAHEE	DATE : 25/02/2024
CHECKED BY : MAHUDHEE	

REVISION NO.: R01	DATE : 26/02/2024
REVISED BY: MAAHEE	



REAL ESTATE MANAGEMENT  
 2ND FLOOR, CENTRO MALL, HULHUMALE'  
 REPUBLIC OF MALDIVES  
 TEL: +9603353535, FAX: +9603358892  
 EMAIL: hello@hdc.mv



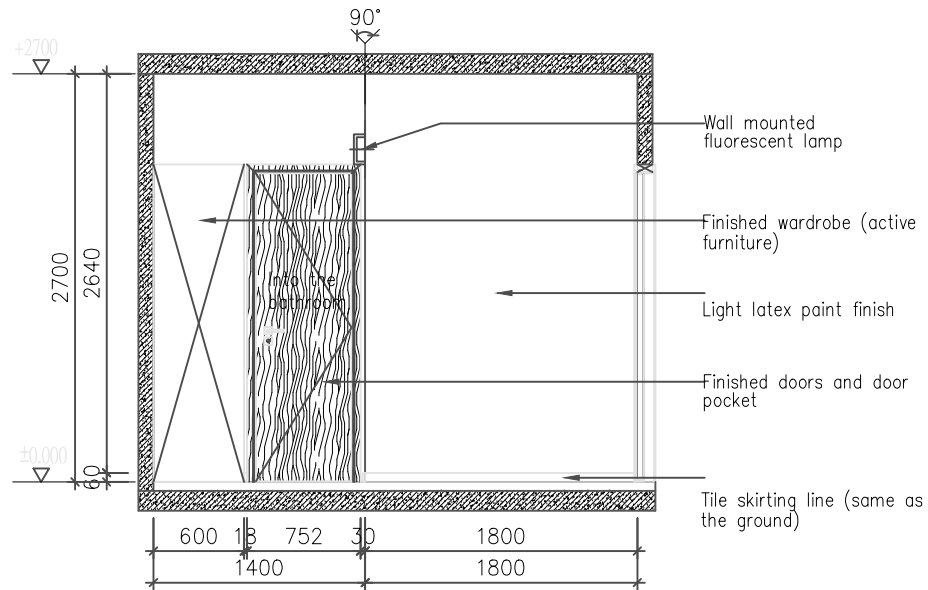

PROPERTY : VINARES 1-10 (LOT: 20507, 20508, 20509 )

A2 TYPE APARTMENT, MASTER BEDROOM

ELEVATION - 02 - D

1:50

PROPERTY : VINARES 1-10 (LOT: 20507,20508, 20509 )		DRAWN BY : MAAHEE	DATE : 25/02/2024	REVISION NO.: R01	DATE : 26/02/2024
DRAWING NAME : A2 TYPE ELEVATION - 02 - D	SCALE: AS GIVEN,A4	CHECKED BY : MAHUDHEE		REVISED BY: MAAHEE	



REAL ESTATE MANAGEMENT  
 2ND FLOOR, CENTRO MALL, HULHUMALE'  
 REPUBLIC OF MALDIVES  
 TEL +9603353535, FAX +9603358892  
 EMAIL : hello@hdc.mv

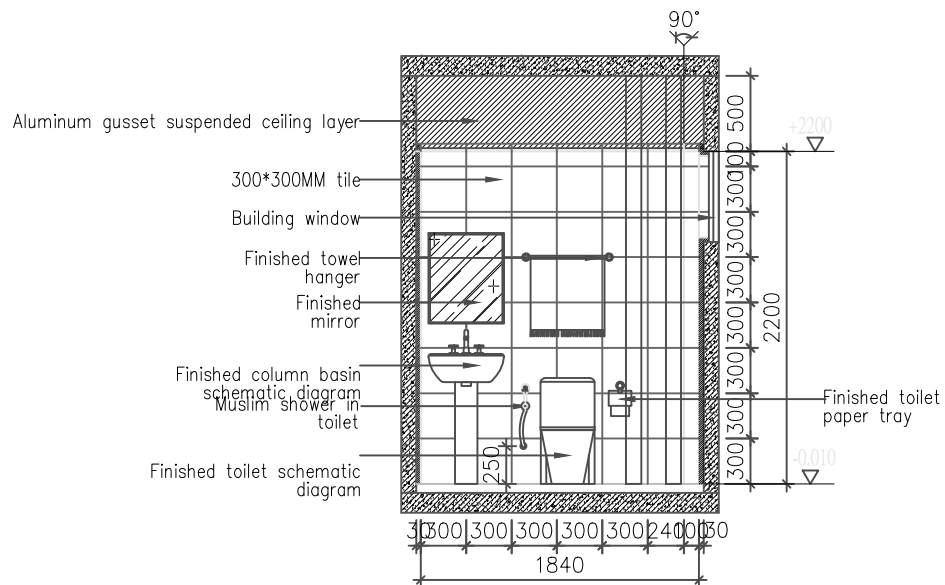

PROPERTY : VINARES 1-10 (LOT: 20507, 20508, 20509 )

A2 TYPE APARTMENT, MASTER BEDROOM

BATHROOM ELEVATION - 03 - A

1:50

PROPERTY : VINARES 1-10 (LOT: 20507,20508, 20509 )		DRAWN BY : MAAHEE	DATE : 25/02/2024	REVISION NO.: R01	DATE : 26/02/2024
DRAWING NAME : A2 TYPE ELEVATION - 03 - A	SCALE: AS GIVEN,A4	CHECKED BY : MAHUDHEE		REVISED BY: MAAHEE	



REAL ESTATE MANAGEMENT  
 2ND FLOOR, CENTRO MALL, HULHUMALE'  
 REPUBLIC OF MALDIVES  
 TEL +9603353535, FAX +9603358892  
 EMAIL : hello@hdc.mv

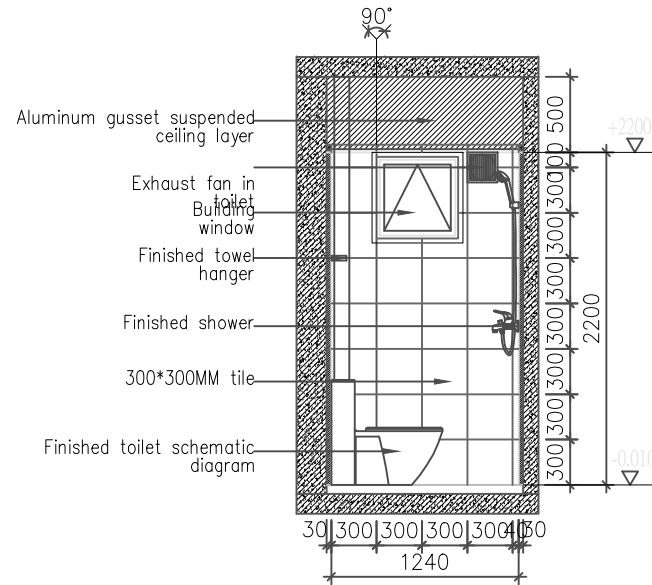

PROPERTY : VINARES 1-10 (LOT: 20507, 20508, 20509 )

A2 TYPE APARTMENT, MASTER BEDROOM

BATHROOM ELEVATION - 03 - B

1:50

PROPERTY : VINARES 1-10 (LOT: 20507,20508, 20509 )		DRAWN BY : MAAHEE	DATE : 25/02/2024	REVISION NO.: R01	DATE : 26/02/2024
DRAWING NAME : A2 TYPE ELEVATION - 03 - B	SCALE: AS GIVEN,A4	CHECKED BY : MAHUDHEE		REVISED BY: MAAHEE	



REAL ESTATE MANAGEMENT  
 2ND FLOOR, CENTRO MALL, HULHUMALE'  
 REPUBLIC OF MALDIVES  
 TEL +9603353535, FAX +9603358892  
 EMAIL : hello@hdc.mv

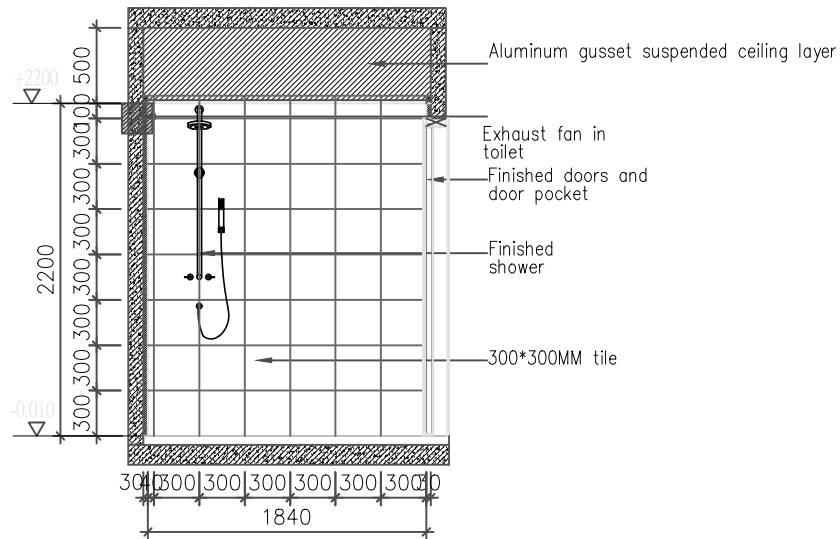

PROPERTY : VINARES 1-10 (LOT: 20507, 20508, 20509 )

A2 TYPE APARTMENT, MASTER BEDROOM

BATHROOM ELEVATION - 03 - C

1:50

PROPERTY : VINARES 1-10 (LOT: 20507,20508, 20509 )	
DRAWING NAME : A2 TYPE ELEVATION - 03 - C	SCALE: AS GIVEN,A4

DRAWN BY : MAAHEE	DATE : 25/02/2024
CHECKED BY : MAHUDHEE	

REVISION NO.: R01	DATE : 26/02/2024
REVISED BY: MAAHEE	



REAL ESTATE MANAGEMENT  
 2ND FLOOR, CENTRO MALL, HULHUMALE'  
 REPUBLIC OF MALDIVES  
 TEL +9603353535, FAX +9603358892  
 EMAIL : hello@hdc.mv

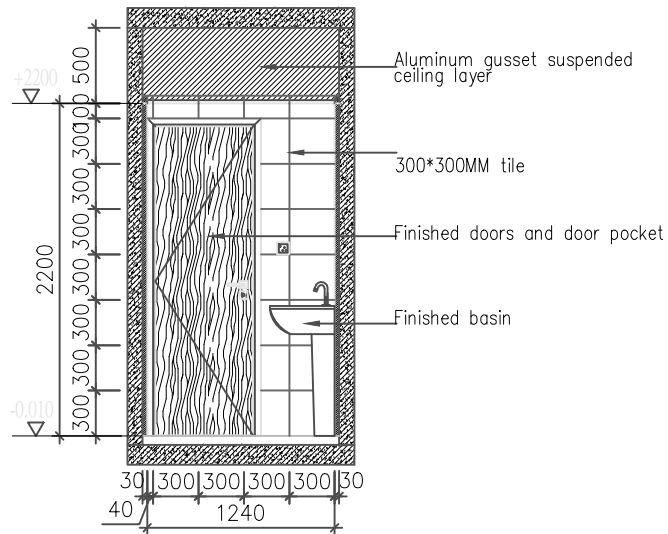

PROPERTY : VINARES 1-10 (LOT: 20507, 20508, 20509 )

A2 TYPE APARTMENT, MASTER BEDROOM

BATHROOM ELEVATION - 03 - D

1:50

PROPERTY : VINARES 1-10 (LOT: 20507,20508, 20509 )		DRAWN BY : MAAHEE	DATE : 25/02/2024	REVISION NO.: R01	DATE : 26/02/2024
DRAWING NAME : A2 TYPE ELEVATION - 03 - D	SCALE: AS GIVEN,A4	CHECKED BY : MAHUDHEE		REVISED BY: MAAHEE	



REAL ESTATE MANAGEMENT  
 2ND FLOOR, CENTRO MALL, HULHUMALE'  
 REPUBLIC OF MALDIVES  
 TEL +9603353535, FAX +9603358892  
 EMAIL : hello@hdc.mv

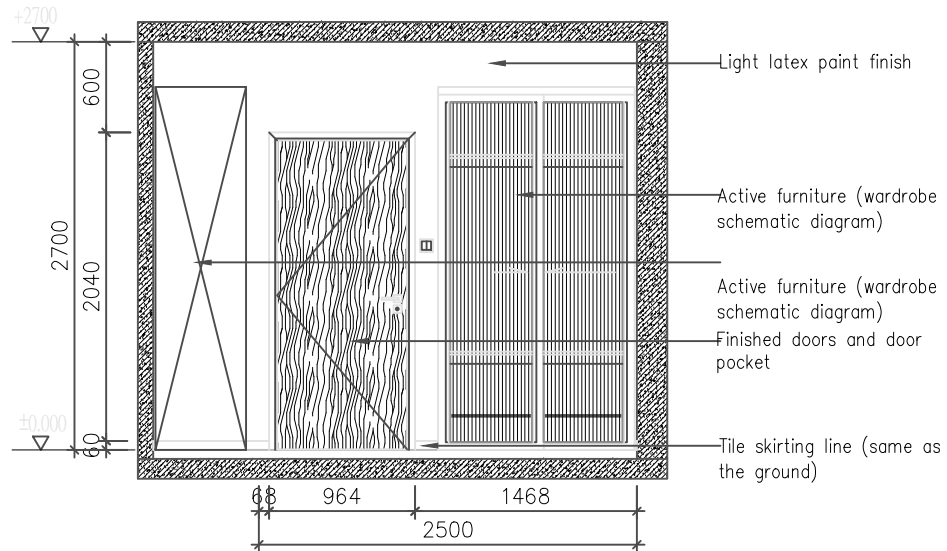

PROPERTY : VINARES 1-10 (LOT: 20507, 20508, 20509 )

A2 TYPE APARTMENT, BEDROOM I

ELEVATION - 04 - A

1:50

PROPERTY : VINARES 1-10 (LOT: 20507,20508, 20509 )		DRAWN BY : MAAHEE	DATE : 25/02/2024	REVISION NO.: R01	DATE : 26/02/2024
DRAWING NAME : A2 TYPE ELEVATION - 04 - A	SCALE: AS GIVEN,A4	CHECKED BY : MAHUDHEE		REVISED BY: MAAHEE	



REAL ESTATE MANAGEMENT  
 2ND FLOOR, CENTRO MALL, HULHUMALE'  
 REPUBLIC OF MALDIVES  
 TEL +9603353535, FAX +9603358892  
 EMAIL : hello@hdc.mv

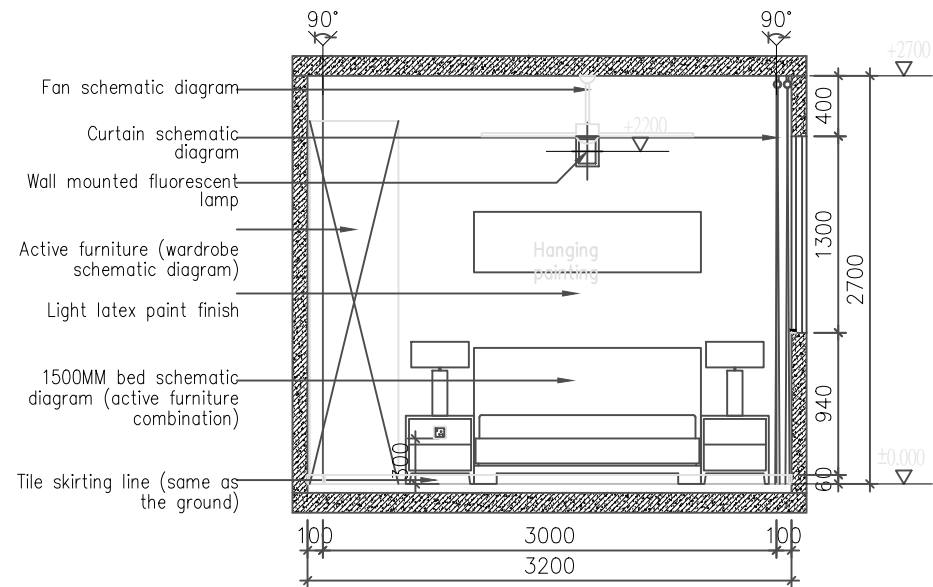

PROPERTY : VINARES 1-10 (LOT: 20507, 20508, 20509 )

A2 TYPE APARTMENT, BEDROOM I

ELEVATION - 04 - B

1:50

PROPERTY : VINARES 1-10 (LOT: 20507,20508, 20509 )

DRAWN BY : MAAHEE

DATE : 25/02/2024

REVISION NO.: R01

DATE : 26/02/2024

DRAWING NAME : A2 TYPE ELEVATION - 04 - B

SCALE: AS GIVEN,A4

CHECKED BY : MAHUDHEE

REVISED BY: MAAHEE



REAL ESTATE MANAGEMENT  
2ND FLOOR, CENTRO MALL, HULHUMALE'  
REPUBLIC OF MALDIVES  
TEL +9603353535, FAX +9603358892  
EMAIL : hello@hdc.mv

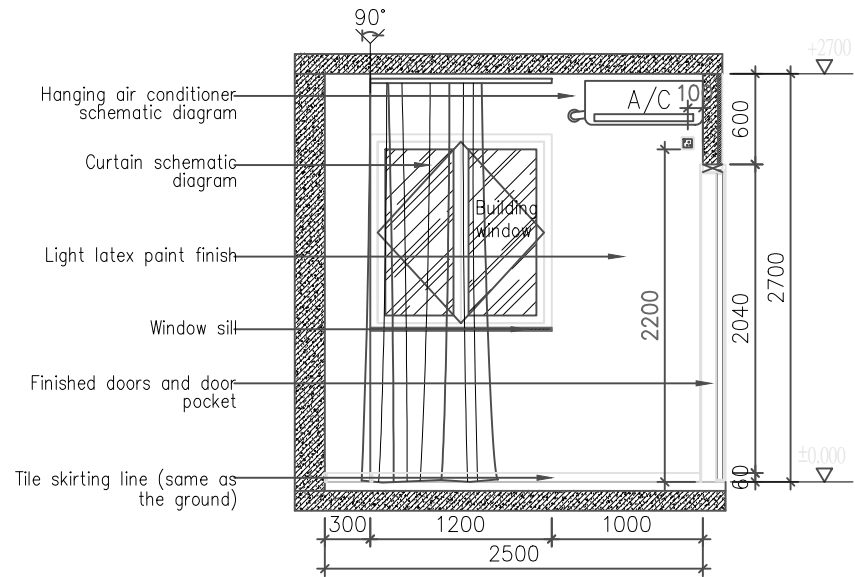

PROPERTY : VINARES 1-10 (LOT: 20507, 20508, 20509 )

A2 TYPE APARTMENT, BEDROOM I

ELEVATION - 04 - C

1:50

PROPERTY : VINARES 1-10 (LOT: 20507,20508, 20509 )		DRAWN BY : MAAHEE	DATE : 25/02/2024	REVISION NO.: R01	DATE : 26/02/2024
DRAWING NAME : A2 TYPE ELEVATION - 04 - C	SCALE: AS GIVEN,A4	CHECKED BY : MAHUDHEE		REVISED BY: MAAHEE	



REAL ESTATE MANAGEMENT  
 2ND FLOOR, CENTRO MALL, HULHUMALE'  
 REPUBLIC OF MALDIVES  
 TEL +9603353535, FAX +9603358892  
 EMAIL : hello@hdc.mv



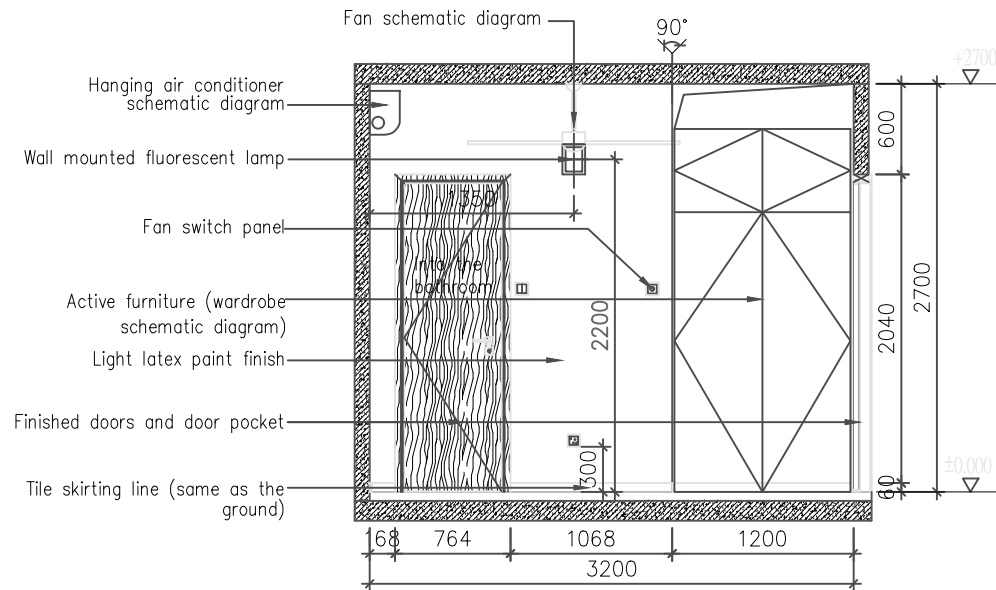

PROPERTY : VINARES 1-10 (LOT: 20507, 20508, 20509 )

A2 TYPE APARTMENT, BATHROOM I  
ELEVATION - 04 - D

1:50

PROPERTY : VINARES 1-10 (LOT: 20507,20508, 20509 )		DRAWN BY : MAAHEE	DATE : 25/02/2024	REVISION NO.: R01	DATE : 26/02/2024
DRAWING NAME : A2 TYPE ELEVATION - 04 - D	SCALE: AS GIVEN,A4	CHECKED BY : MAHUDHEE		REVISED BY: MAAHEE	



REAL ESTATE MANAGEMENT  
 2ND FLOOR, CENTRO MALL, HULHUMALE'  
 REPUBLIC OF MALDIVES  
 TEL +9603353535, FAX +9603358892  
 EMAIL : hello@hdc.mv

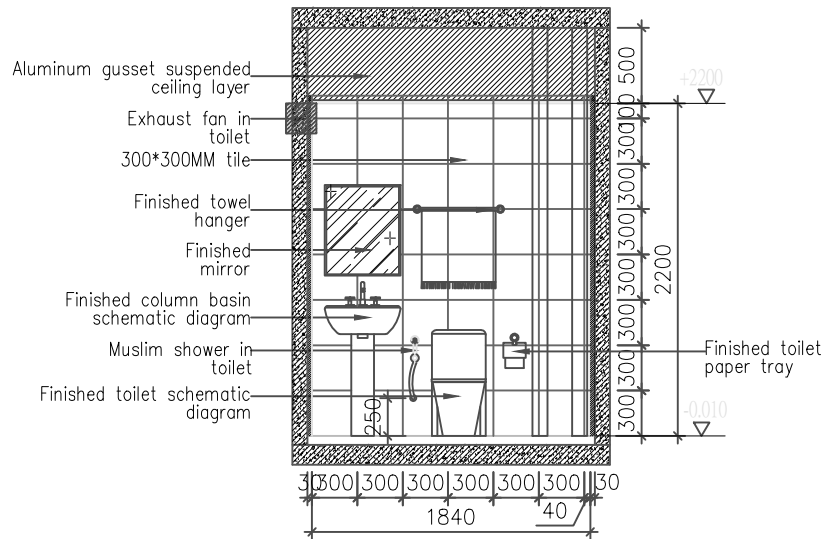

PROPERTY : VINARES 1-10 (LOT: 20507, 20508, 20509 )

A2 TYPE APARTMENT, BEDROOM I - BATHROOM

ELEVATION - 05 - A

1:50

PROPERTY : VINARES 1-10 (LOT: 20507,20508, 20509 )	
DRAWING NAME : A2 TYPE ELEVATION - 05 - A	SCALE: AS GIVEN,A4

DRAWN BY : MAAHEE	DATE : 25/02/2024
CHECKED BY : MAHUDHEE	

REVISION NO.: R01	DATE : 26/02/2024
REVISED BY: MAAHEE	



REAL ESTATE MANAGEMENT  
 2ND FLOOR, CENTRO MALL, HULHUMALE'  
 REPUBLIC OF MALDIVES  
 TEL +9603353535, FAX +9603358892  
 EMAIL : hello@hdc.mv

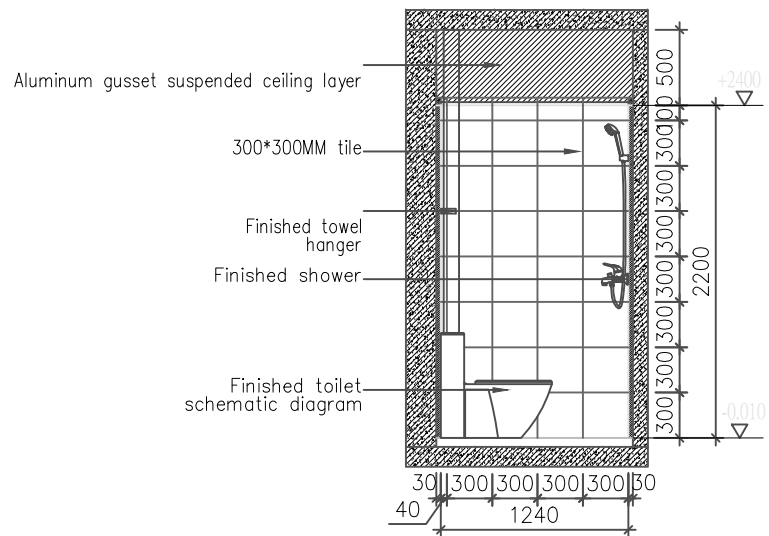

PROPERTY : VINARES 1-10 (LOT: 20507, 20508, 20509 )

A2 TYPE APARTMENT, BEDROOM I - BATHROOM

ELEVATION - 05 - B

1:50

PROPERTY : VINARES 1-10 (LOT: 20507,20508, 20509 )

DRAWN BY : MAAHEE

DATE : 25/02/2024

REVISION NO.: R01

DATE : 26/02/2024

DRAWING NAME : A2 TYPE ELEVATION - 05 - B

SCALE: AS GIVEN,A4

CHECKED BY : MAHUDHEE

REVISED BY: MAAHEE



REAL ESTATE MANAGEMENT  
 2ND FLOOR, CENTRO MALL, HULHUMALE'  
 REPUBLIC OF MALDIVES  
 TEL +9603353535, FAX +9603358892  
 EMAIL : hello@hdc.mv

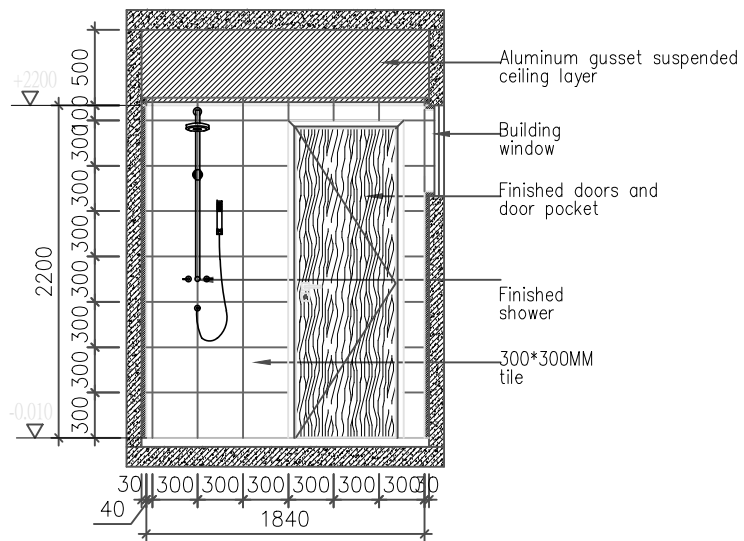

PROPERTY : VINARES 1-10 (LOT: 20507, 20508, 20509 )

A2 TYPE APARTMENT, BEDROOM I - BATHROOM

ELEVATION - 05 - C

1:50

PROPERTY : VINARES 1-10 (LOT: 20507,20508, 20509 )	
DRAWING NAME : A2 TYPE ELEVATION - 05 - C	SCALE: AS GIVEN,A4

DRAWN BY : MAAHEE	DATE : 25/02/2024
CHECKED BY : MAHUDHEE	

REVISION NO.: R01	DATE : 26/02/2024
REVISED BY: MAAHEE	



REAL ESTATE MANAGEMENT  
 2ND FLOOR, CENTRO MALL, HULHUMALE'  
 REPUBLIC OF MALDIVES  
 TEL +9603353535, FAX +9603358892  
 EMAIL : hello@hdc.mv

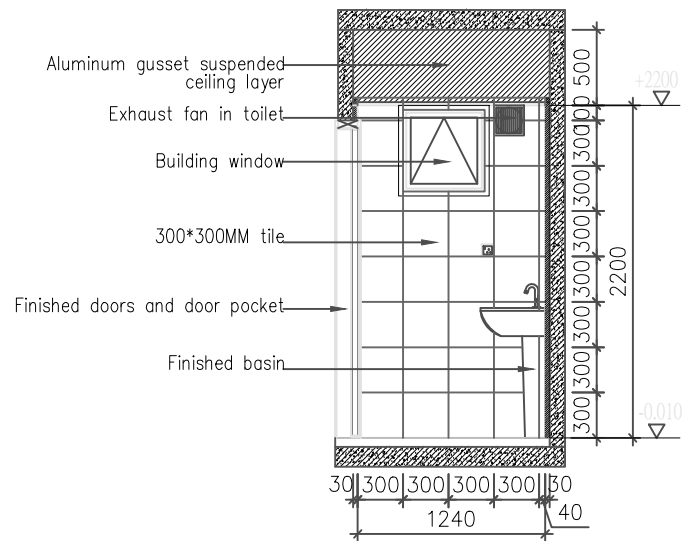

PROPERTY : VINARES 1-10 (LOT: 20507, 20508, 20509 )  
A2 TYPE APARTMENT, BATHROOM 1 - BATHROOM  
ELEVATION - 05 - D  
 1:50

PROPERTY : VINARES 1-10 (LOT: 20507,20508, 20509 )	
DRAWING NAME : A2 TYPE ELEVATION - 05 - D	SCALE: AS GIVEN,A4

DRAWN BY : MAAHEE	DATE : 25/02/2024
CHECKED BY : MAHUDHEE	

REVISION NO.: R01	DATE : 26/02/2024
REVISED BY: MAAHEE	



**HOUSING  
DEVELOPMENT  
CORPORATION**

REAL ESTATE MANAGEMENT  
 2ND FLOOR, CENTRO MALL, HULHUMALE'  
 REPUBLIC OF MALDIVES  
 TEL +9603353535, FAX +9603358892  
 EMAIL : hello@hdc.mv

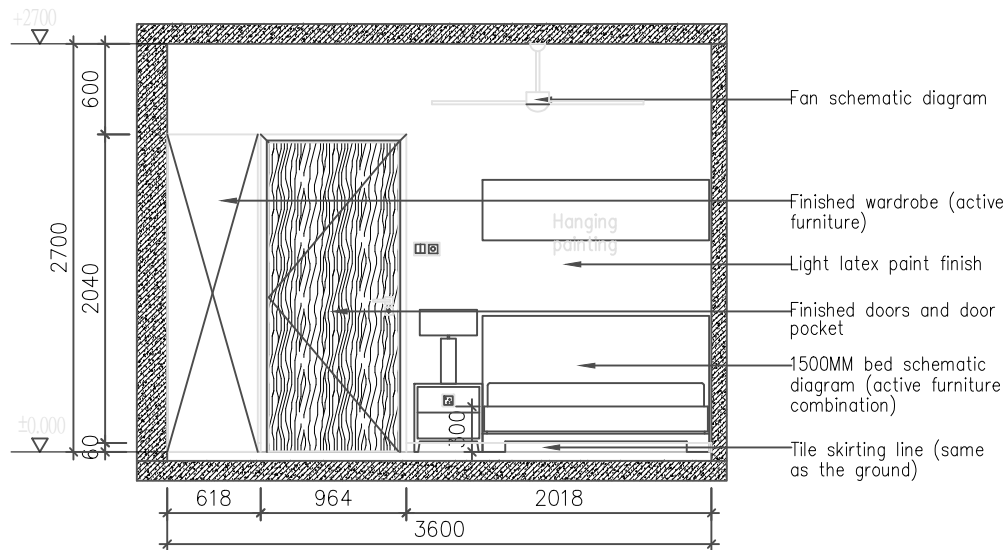

PROPERTY : VINARES 1-10 (LOT: 20507, 20508, 20509 )

A2 TYPE APARTMENT, BEDROOM II

ELEVATION - 06 - A

1:50

PROPERTY : VINARES 1-10 (LOT: 20507,20508, 20509 )

DRAWN BY : MAAHEE

DATE : 25/02/2024

REVISION NO.: R01

DATE : 26/02/2024

DRAWING NAME : A2 TYPE ELEVATION - 06 - A

SCALE: AS GIVEN,A4

CHECKED BY : MAHUDHEE

REVISED BY: MAAHEE



REAL ESTATE MANAGEMENT  
2ND FLOOR, CENTRO MALL, HULHUMALE'  
REPUBLIC OF MALDIVES  
TEL +9603353535, FAX +9603358892  
EMAIL : hello@hdc.mv

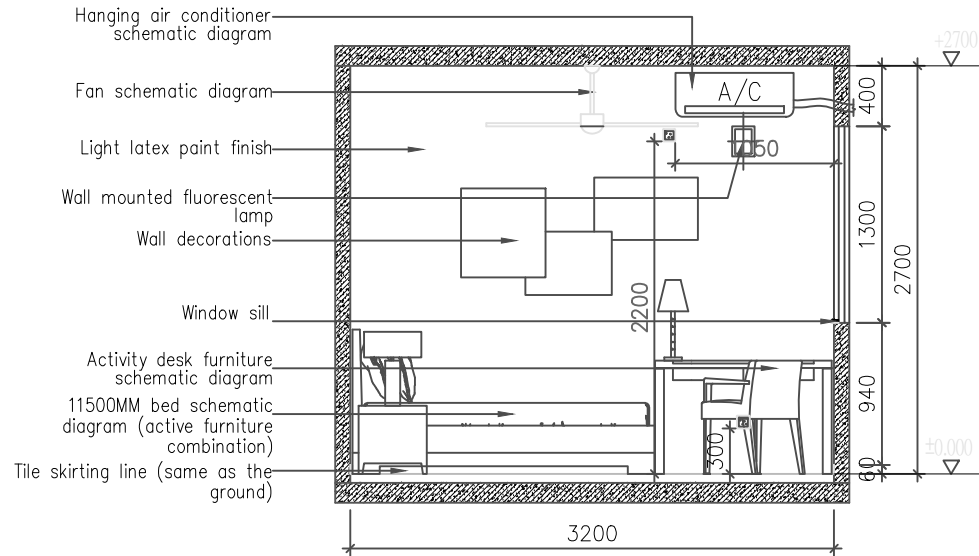

PROPERTY : VINARES 1-10 (LOT: 20507, 20508, 20509 )

A2 TYPE APARTMENT, BEDROOM II  
ELEVATION - 06 - B

1:50

PROPERTY : VINARES 1-10 (LOT: 20507,20508, 20509 )		DRAWN BY : MAAHEE	DATE : 25/02/2024	REVISION NO.: R01	DATE : 26/02/2024
DRAWING NAME : A2 TYPE ELEVATION - 06 - B	SCALE: AS GIVEN,A4	CHECKED BY : MAHUDHEE		REVISED BY: MAAHEE	



REAL ESTATE MANAGEMENT  
 2ND FLOOR, CENTRO MALL, HULHUMALE'  
 REPUBLIC OF MALDIVES  
 TEL +9603353535, FAX +9603358892  
 EMAIL : hello@hdc.mv

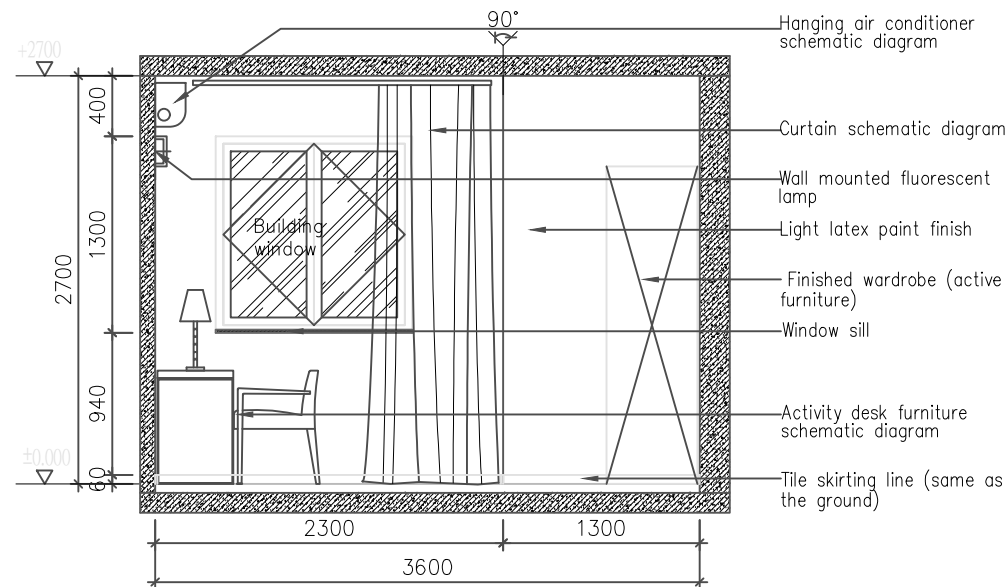

PROPERTY : VINARES 1-10 (LOT: 20507, 20508, 20509 )

A2 TYPE APARTMENT, BEDROOM II

ELEVATION - 06 - C

1:50

PROPERTY : VINARES 1-10 (LOT: 20507,20508, 20509 )	
DRAWING NAME : A2 TYPE ELEVATION - 06 - C	SCALE: AS GIVEN,A4

DRAWN BY : MAAHEE	DATE : 25/02/2024
CHECKED BY : MAHUDHEE	

REVISION NO.: R01	DATE : 26/02/2024
REVISED BY: MAAHEE	



REAL ESTATE MANAGEMENT  
 2ND FLOOR, CENTRO MALL, HULHUMALE'  
 REPUBLIC OF MALDIVES  
 TEL +9603353535, FAX +9603358892  
 EMAIL : hello@hdc.mv





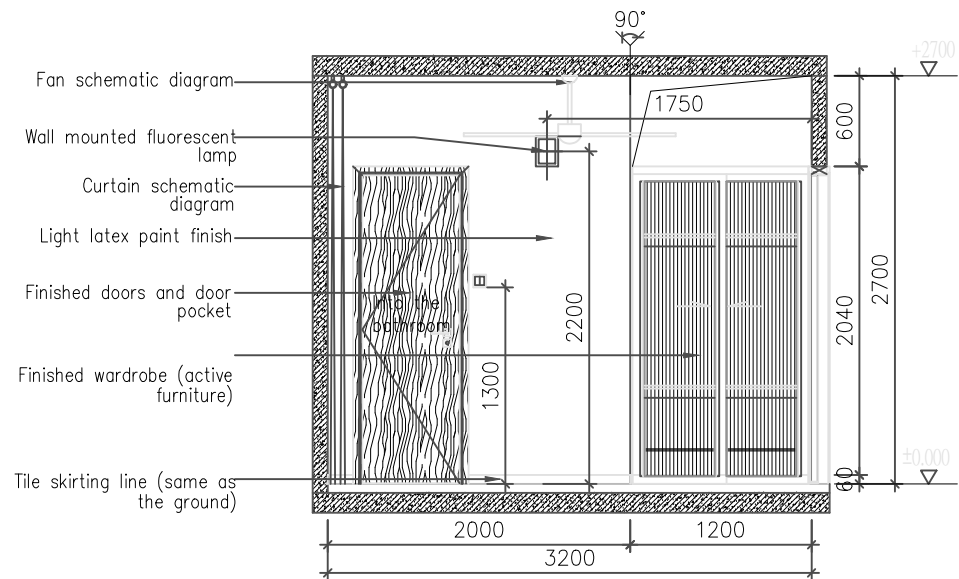

PROPERTY : VINARES 1-10 (LOT: 20507, 20508, 20509 )

A2 TYPE APARTMENT, BATHROOM II

ELEVATION - 06 - D

1:50

PROPERTY : VINARES 1-10 (LOT: 20507,20508, 20509 )

DRAWN BY : MAAHEE

DATE : 25/02/2024

REVISION NO.: R01

DATE : 26/02/2024

DRAWING NAME : A2 TYPE ELEVATION - 06 - D

SCALE: AS GIVEN,A4

CHECKED BY : MAHUDHEE

REVISED BY: MAAHEE



REAL ESTATE MANAGEMENT  
2ND FLOOR, CENTRO MALL, HULHUMALE'  
REPUBLIC OF MALDIVES  
TEL +9603353535, FAX +9603358892  
EMAIL : hello@hdc.mv

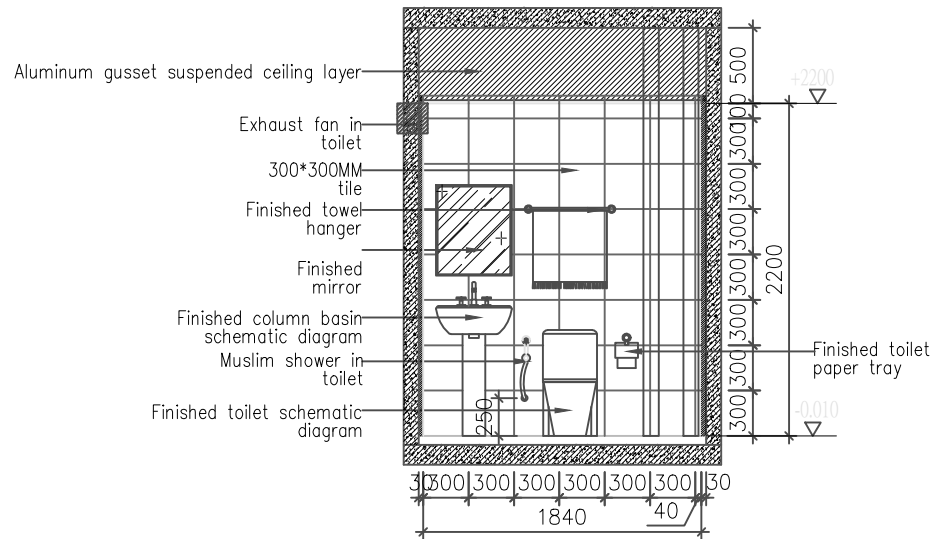

PROPERTY : VINARES 1-10 (LOT: 20507, 20508, 20509 )

A2 TYPE APARTMENT, BEDROOM II - BATHROOM

ELEVATION - 07 - A

1:50

PROPERTY : VINARES 1-10 (LOT: 20507,20508, 20509 )	DRAWN BY : MAAHEE	DATE : 25/02/2024	REVISION NO.: R01	DATE : 26/02/2024
DRAWING NAME : A2 TYPE ELEVATION - 07 - A	CHECKED BY : MAHUDHEE		REVISED BY: MAAHEE	



REAL ESTATE MANAGEMENT  
 2ND FLOOR, CENTRO MALL, HULHUMALE'  
 REPUBLIC OF MALDIVES  
 TEL. +9603353535, FAX +9603358892  
 EMAIL : hello@hdc.mv

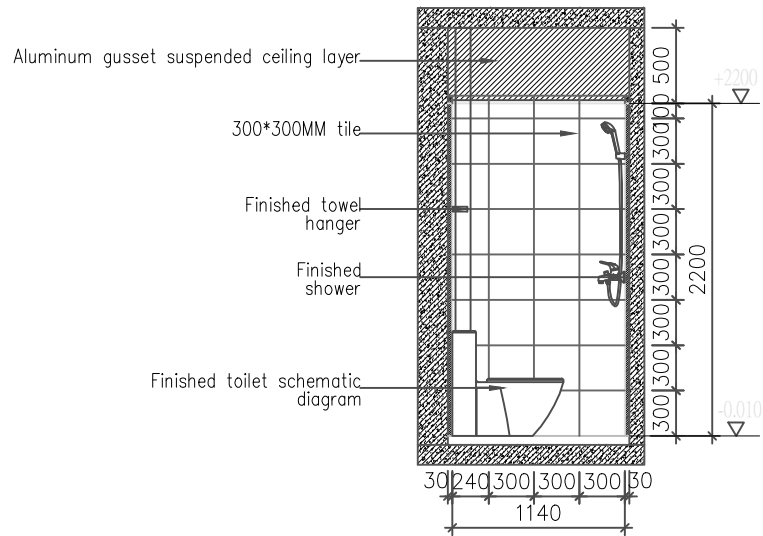

PROPERTY : VINARES 1-10 (LOT: 20507, 20508, 20509 )

A2 TYPE APARTMENT, BEDROOM II - BATHROOM

ELEVATION - 07 - B

1:50

PROPERTY : VINARES 1-10 (LOT: 20507,20508, 20509 )		DRAWN BY : MAAHEE	DATE : 25/02/2024	REVISION NO.: R01	DATE : 26/02/2024
DRAWING NAME : A2 TYPE ELEVATION - 07 - B	SCALE: AS GIVEN,A4	CHECKED BY : MAHUDHEE		REVISED BY: MAAHEE	



REAL ESTATE MANAGEMENT  
 2ND FLOOR, CENTRO MALL, HULHUMALE'  
 REPUBLIC OF MALDIVES  
 TEL +9603353535, FAX +9603358892  
 EMAIL : hello@hdc.mv

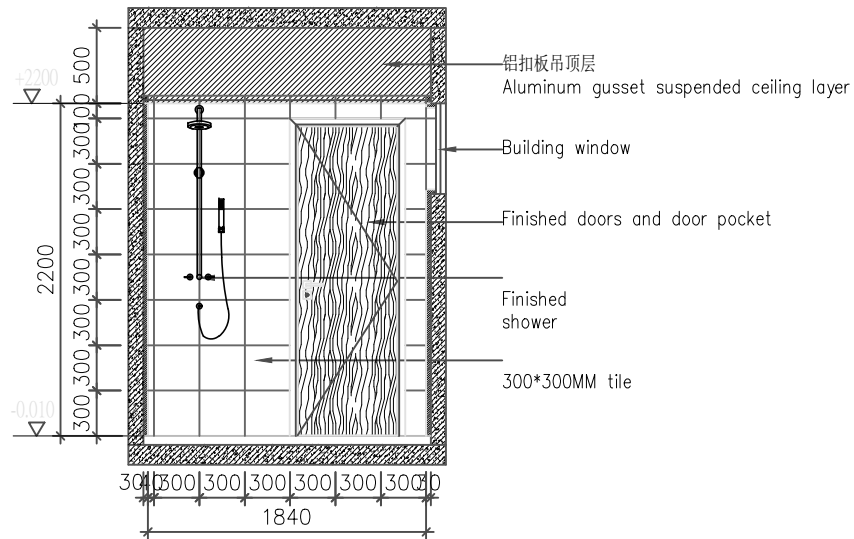

PROPERTY : VINARES 1-10 (LOT: 20507, 20508, 20509 )

A2 TYPE APARTMENT, BEDROOM II - BATHROOM

ELEVATION - 07 - C

1:50

PROPERTY : VINARES 1-10 (LOT: 20507,20508, 20509 )		DRAWN BY : MAAHEE	DATE : 25/02/2024	REVISION NO.: R01	DATE : 26/02/2024
DRAWING NAME : A2 TYPE ELEVATION - 07 - C	SCALE: AS GIVEN,A4	CHECKED BY : MAHUDHEE		REVISED BY: MAAHEE	



REAL ESTATE MANAGEMENT  
2ND FLOOR, CENTRO MALL, HULHUMALE'  
REPUBLIC OF MALDIVES  
TEL. +9603353535, FAX +9603358892  
EMAIL : hello@hdc.mv

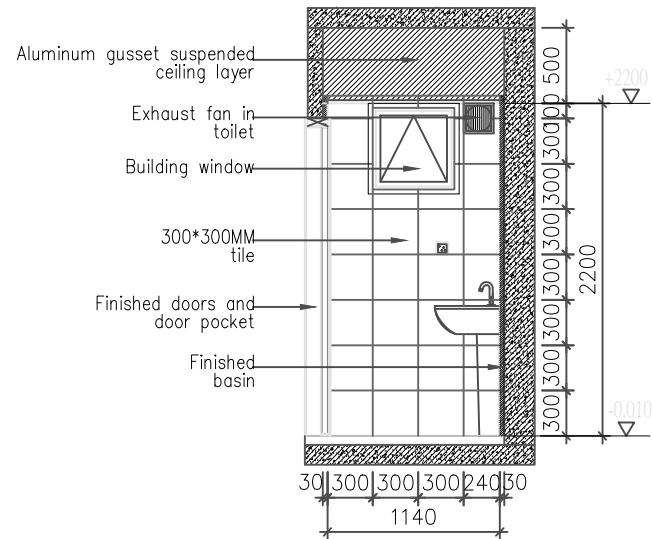

PROPERTY : VINARES 1-10 (LOT: 20507, 20508, 20509 )

A2 TYPE APARTMENT, BATHROOM II - BATHROOM

ELEVATION - 07 - D

1:50

PROPERTY : VINARES 1-10 (LOT: 20507,20508, 20509 )		DRAWN BY : MAAHEE		DATE : 25/02/2024		REVISION NO.: R01		DATE : 26/02/2024	
DRAWING NAME : A2 TYPE ELEVATION - 07 - D		SCALE: AS GIVEN,A4		CHECKED BY : MAHUDHEE		REVISED BY: MAAHEE			



REAL ESTATE MANAGEMENT  
 2ND FLOOR, CENTRO MALL, HULHUMALE'  
 REPUBLIC OF MALDIVES  
 TEL +9603353535, FAX +9603358892  
 EMAIL : hello@hdc.mv